

Handrails, Dual Rails & Combination Rail

Introduction

Gradus handrails, Dual Rails and combination rail are designed to offer pedestrian guidance and support in addition to a level of surface protection.

Designed for use in interior, horizontal circulation areas, they are suitable for use in a wide range of environments including healthcare, education, commercial office and transport.

The style of profile selected will depend on the types and levels of both pedestrian and wheeled traffic.

Handrails can also be combined with other profiles from the range to provide a complete protection solution.



Countess of Chester Hospital



Handrails



Dual Rails



Combination Rail

SHR40P Handrail

Features

- > Handrails are designed to offer pedestrian guidance and support in addition to a level of surface protection
- > Aluminium retainer with PVC-u covers and matching PVC-u accessories
- > Suitable for use in a wide range of environments including healthcare, education and transport
- > Reveals provide tight, neat joints and are made from a naturally bactericidal polymer that inhibits the growth of bacteria

Information

- > Supplied in 4.0m lengths
- > Accessories include reveal(s)
- > Replacement components available to purchase
- > Handrails feature a smooth finish in line with HBN 00-04
- > All options are designed to meet guidelines in HBN 00-10, HBN 00-04, BS 8300-2:2018 and Approved Documents K and M of The Building Regulations 2010
- > 32 colour options see page 42

Components



SHR40P
aluminium retainer with PVC-u cover

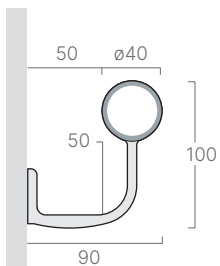

SHR403
anodised aluminium
standard bracket

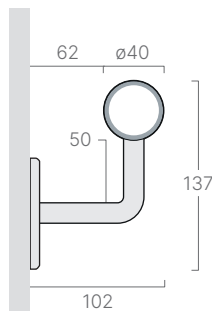

SHR40959
stainless steel
bracket

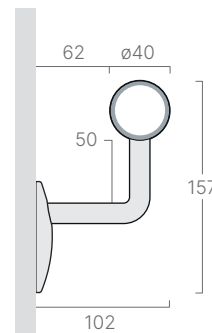

SHR40951
stainless steel
bracket with cover

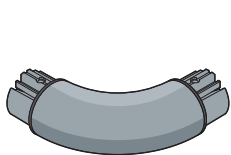

SHR402P
universal corner

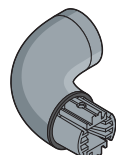

SHR404P
universal return

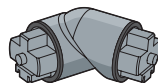

SHR408P
variable angle



SHR407
jointing splice



SHR406P
end stop



Brighton 3Ts - Royal Sussex County Hospital

SHR40W Handrail

Features

- > Aluminium handrail with wood effect finish with PVC-u accessories
- > 4 wood effects see page 41 for availability and page 55 for larger colour swatches
- > Accessories are available in 32 colours, recommended colours are Flint 032, Pebble 011 or Granite 004
- > Reveals provide tight, neat joints and are made from a naturally bactericidal polymer that inhibits the growth of bacteria

Information

- > Supplied in 4.0m lengths
- > Accessories include reveal(s)
- > Replacement components available to purchase
- > Handrails feature a smooth finish in line with HBN 00-04
- > All options are designed to meet guidelines in HBN 00-10, HBN 00-04, BS 8300-2:2018 and Approved Documents K and M of The Building Regulations 2010

Components

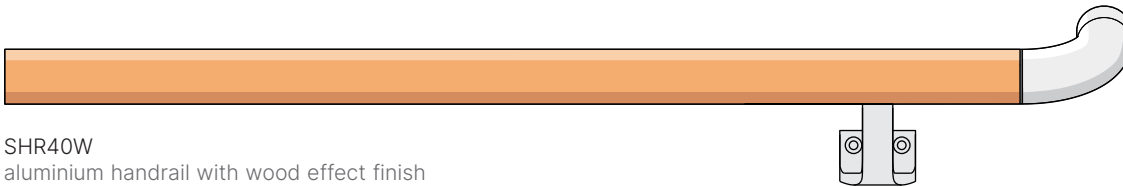

SHR40W
aluminium handrail with wood effect finish

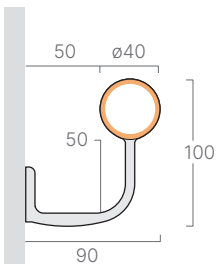

SHR403
anodised aluminium
standard bracket

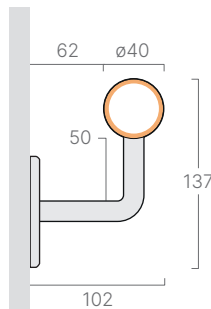

SHR40959
stainless steel
bracket

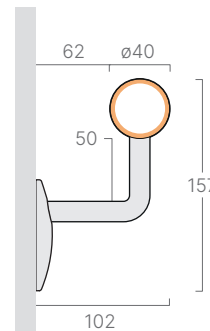

SHR40951
stainless steel
bracket with cover

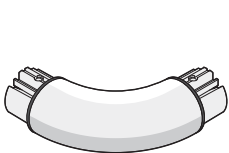

SHR402P
universal corner

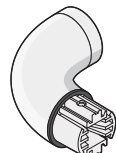

SHR404P
universal return



SHR408P
variable angle



SHR407
jointing splice



SHR406P
end stop



Brighton 3Ts - Royal Sussex County Hospital

SHR40S Handrail

Features

- > Handrails are designed to offer pedestrian guidance and support in addition to a level of surface protection
- > Silver anodised aluminium handrail with PVC-u accessories
- > Accessories are available in 32 colours, recommended colour is Flint 032
- > Reveals provide tight, neat joints and are made from a naturally bactericidal polymer that inhibits the growth of bacteria

Information

- > Supplied in 4.0m lengths
- > Accessories include reveal(s)
- > Replacement components available to purchase
- > Handrails feature a smooth finish in line with HBN 00-04
- > All options are designed to meet guidelines in HBN 00-10, HBN 00-04, BS 8300-2:2018 and Approved Documents K and M of The Building Regulations 2010

Components

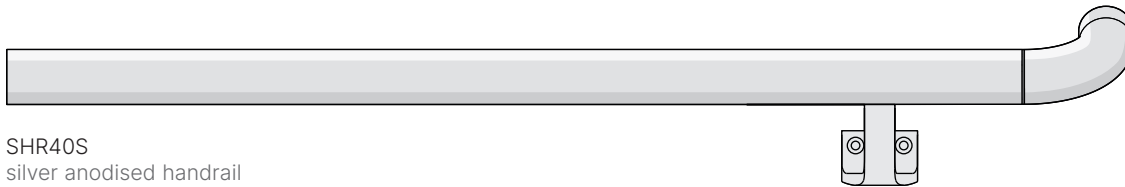

SHR40S
silver anodised handrail

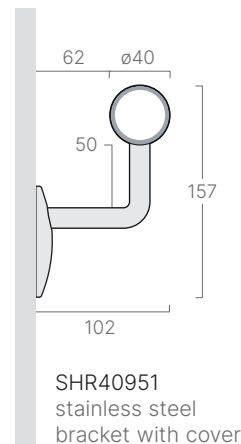
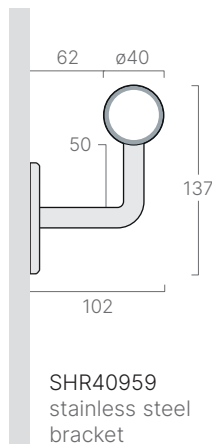
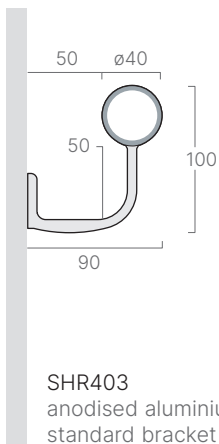

SHR402P
universal corner

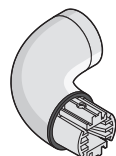

SHR404P
universal return

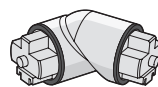

SHR408P
variable angle



SHR407
jointing splice



SHR406P
end stop



Brighton 3Ts - Royal Sussex County Hospital

THR450 Timber Handrail

Features

- > Solid timber handrail with stainless steel or solid timber finishing accessories
- > Supplied pre-lacquered – no on-site finishing required
- > Timber handrail also forms part of D200T Dual Rail (see page 94)
- > 4 timber species available

Information

- > Ash & Oak supplied in 3.2m lengths
- > Maple & Sapele supplied in 3.0m lengths
- > Replacement components available to purchase

Components

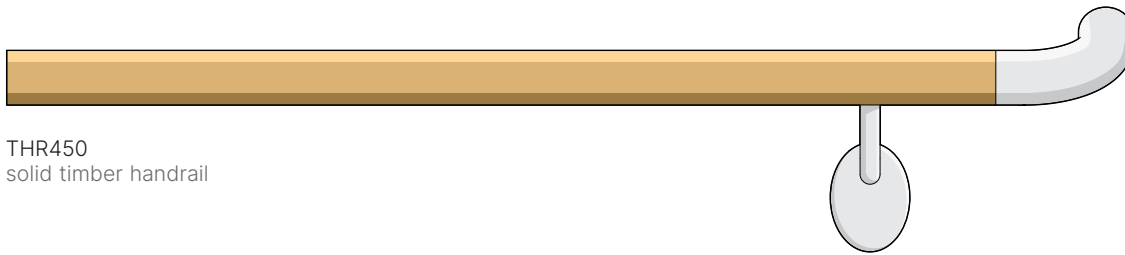

THR450
solid timber handrail

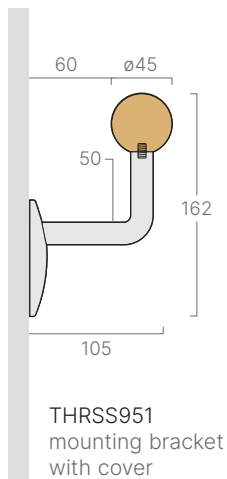

THRSS951
mounting bracket
with cover

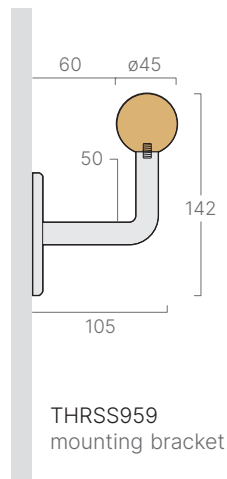

THRSS959
mounting bracket



THRSS454
stainless steel option



THRSSFBC450
collar includes two
THR456 splices



THR454
timber option
THRSSFBC450 collar
required to connect
to handrail



THR456
splice

Colour Availability



401 Ash
LRV 42.92



402 Oak
LRV 28.06

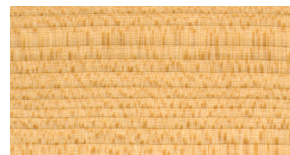

403 Maple
LRV 36.84

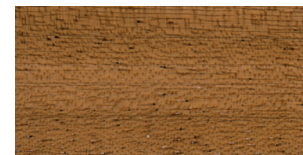

406 Sapele
LRV 15.11



Visit: www.gradus.com
for full details



Dimensions shown are nominal
Illustrations are in mm



100%
Recyclable



NBS Source
PARTNER



Brighton 3Ts - Royal Sussex County Hospital

SSHR42 Stainless Steel Handrail

Features

- > Comprise stainless steel handrail, brackets and matching accessories
- > Can be curved for bespoke applications (contact Gradus for radii information)
- > Suitable for interior environments

Information

- > Satin or Polished finish
- > Supplied in 3.0m lengths
- > Replacement components available to purchase
- > Complementary corner guards see 110

Components

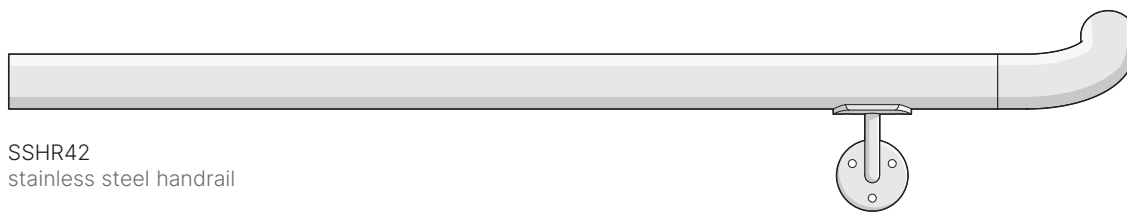

SSHR42
stainless steel handrail

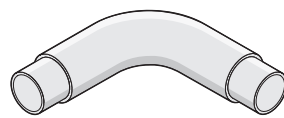
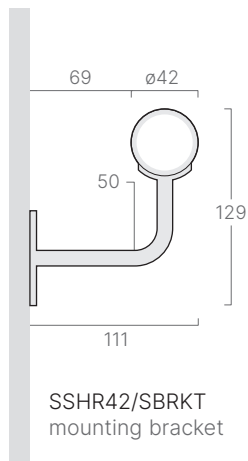

SSHR42/A90
inside/outside corner 90°

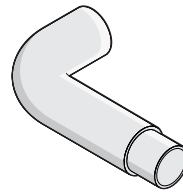

SSHR42/RET
wall return

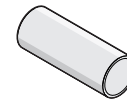

SSHR42/SPLICE
liner joint



SSHR42/EC
flat end cap

Colour Availability



Stainless Steel
LRV 59.95



D200P Dual Rail

Features

- > PVC-u wall guard with PVC-u handrail and PVC-u accessories
- > Dual Rail provides the ideal solution where both a handrail and wall guard are required as a combined system
- > Ideal for healthcare environments where pedestrian support is required in addition to protection against severe impact
- > Reveals provide tight, neat joints and are made from a naturally bactericidal polymer that inhibits the growth of bacteria

Information

- > Supplied in 4.0m lengths
- > Accessories include reveal(s)
- > For multiple length installations use handrail splice SHR407 with wall guard splice D200JS
- > Replacement components available to purchase
- > All options are designed to meet guidelines in HBN 00-10, HBN 00-04, BS 8300-2:2018 and Approved Documents K and M
- > Wall guard and handrail available in 32 colour options see page 42

Components



D200P

PVC-u wall guard with PVC-u handrail and PVC-u accessories

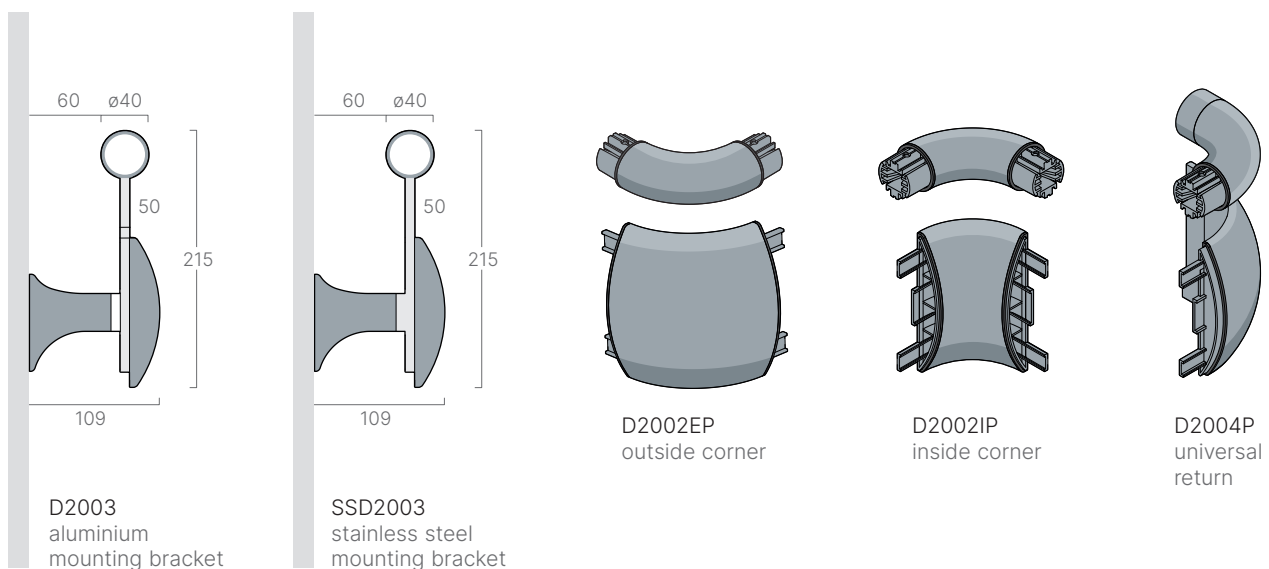



D200T Dual Rail

Features

- > PVC-u wall guard with timber handrail and stainless steel accessories
- > Dual Rail provides the ideal solution where both a handrail and wall guard are required as a combined system
- > Ideal for healthcare environments where pedestrian support is required in addition to protection against severe impact
- > Reveals provide tight, neat joints and are made from a naturally bactericidal polymer that inhibits the growth of bacteria

Information

- > Supplied in 4.0m lengths
- > Accessories include reveal(s)
- > For multiple length installations use THRSSFBC450 with wall guard splice D200JS
- > Replacement components available to purchase
- > All options are designed to meet guidelines in HBN 00-10, HBN 00-04, BS 8300-2:2018 and Approved Documents K and M
- > Wall Guard available in 32 colour options see page 42
Handrail available in 4 timber species see page 88

Components

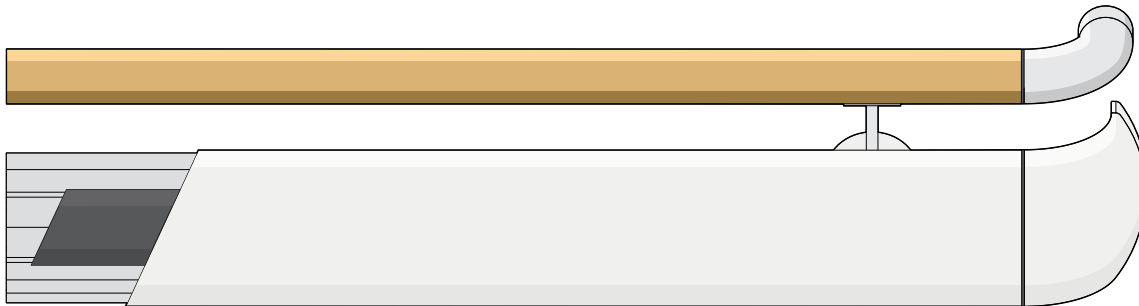

D200T

PVC-u wall guard with timber handrail and stainless steel accessories

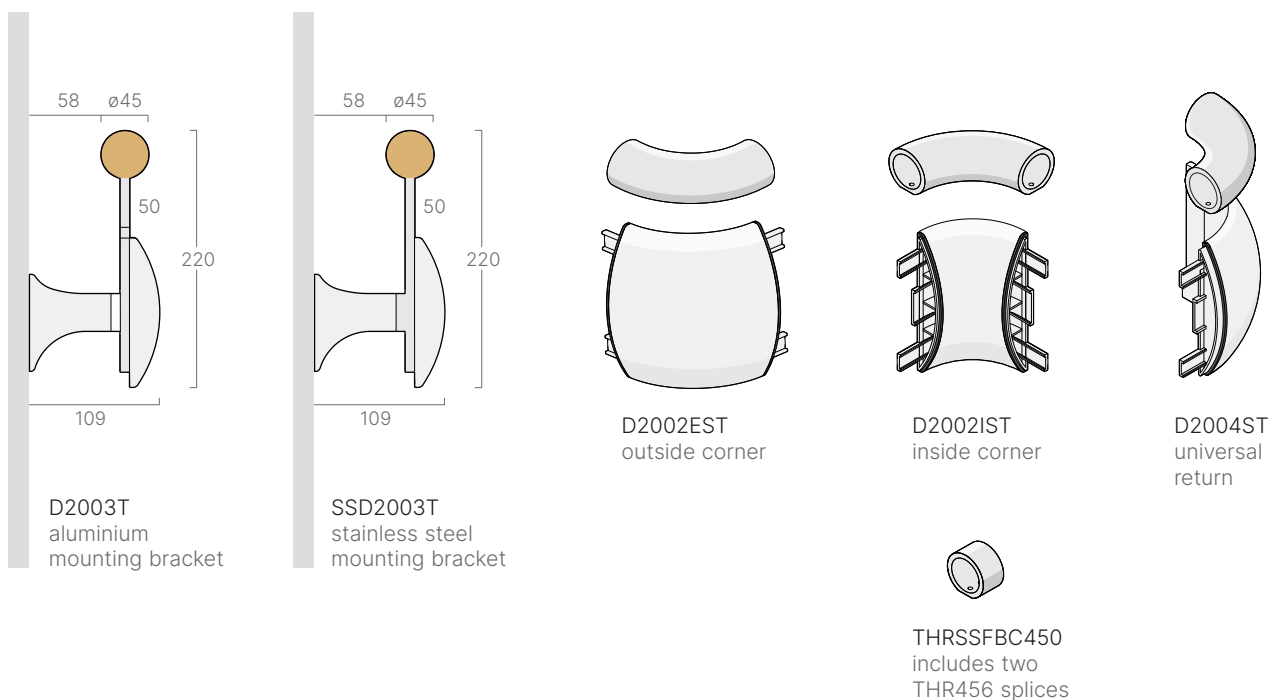

D200W Dual Rail

Features

- > PVC-u wall guard with wood effect aluminium handrail and PVC-u accessories
- > Dual Rail provides the ideal solution where both a handrail and wall guard are required as a combined system
- > Ideal for healthcare environments where pedestrian support is required in addition to protection against severe impact
- > Reveals provide tight, neat joints and are made from a naturally bactericidal polymer that inhibits the growth of bacteria

Information

- > Supplied in 4.0m lengths
- > Accessories include reveal(s)
- > For multiple length installations use handrail splice SHR407 with wall guard splice D200JS
- > Replacement components available to purchase
- > All options are designed to meet guidelines in HBN 00-10, HBN 00-04, BS 8300-2:2018 and Approved Documents K and M
- > Wall Guard available in 32 colour options see page 42
Handrail available in 5 wood effects see page 55

Components

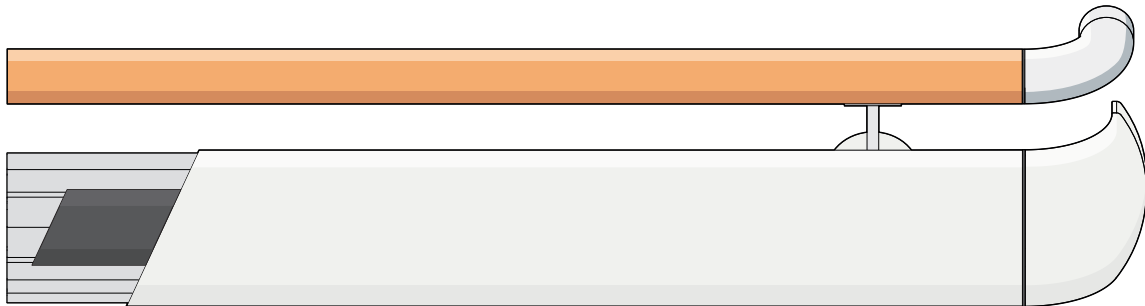

D200W

PVC-u wall guard with wood effect aluminium handrail and PVC-u accessories

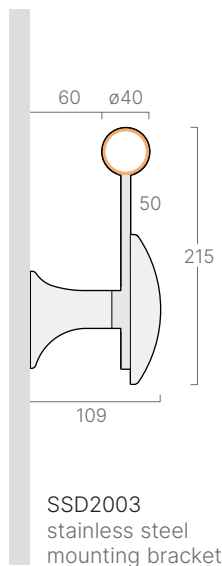
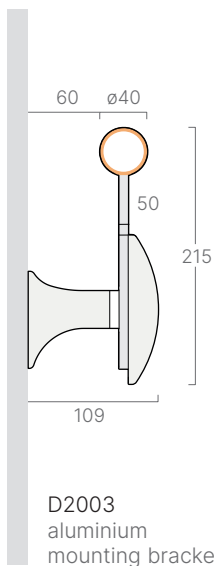

D2002ECP
outside corner

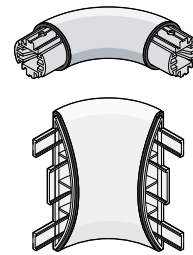

D2002ICP
inside corner

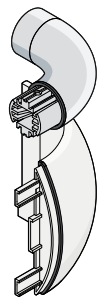

D2004CP
universal
return



Visit: www.gradus.com
for full details



Dimensions shown are nominal
Illustrations are in mm



100%
Recyclable



NBS Source
PARTNER

D200S Dual Rail

Features

- > PVC-u wall guard with silver anodised aluminium handrail and PVC-u accessories
- > Dual Rail provides the ideal solution where both a handrail and wall guard are required as a combined system
- > Ideal for healthcare environments where pedestrian support is required in addition to protection against severe impact
- > Reveals provide tight, neat joints and are made from a naturally bactericidal polymer that inhibits the growth of bacteria

Information

- > Supplied in 4.0m lengths
- > Accessories include reveal(s)
- > For multiple length installations use handrail splice SHR407 with wall guard splice D200JS
- > Replacement components available to purchase
- > All options are designed to meet guidelines in HBN 00-10, HBN 00-04, BS 8300-2:2018 and Approved Documents K and M
- > Wall Guard available in 32 colour options see page 42
Handrail available in Silver Anodised finish

Components

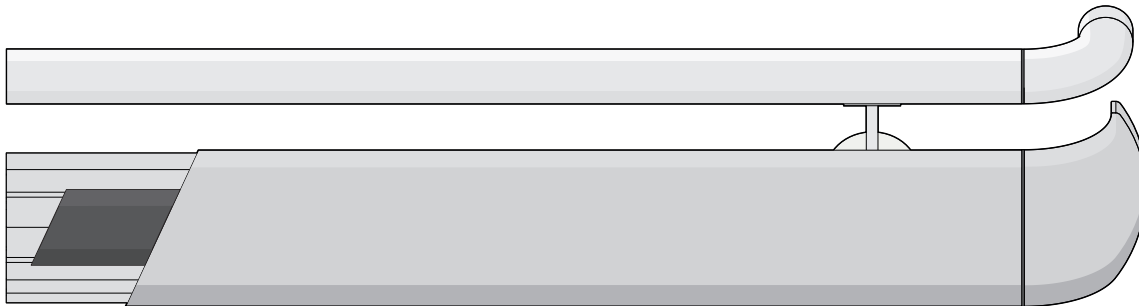

D200S

PVC-u wall guard with silver anodised aluminium handrail and PVC-u accessories

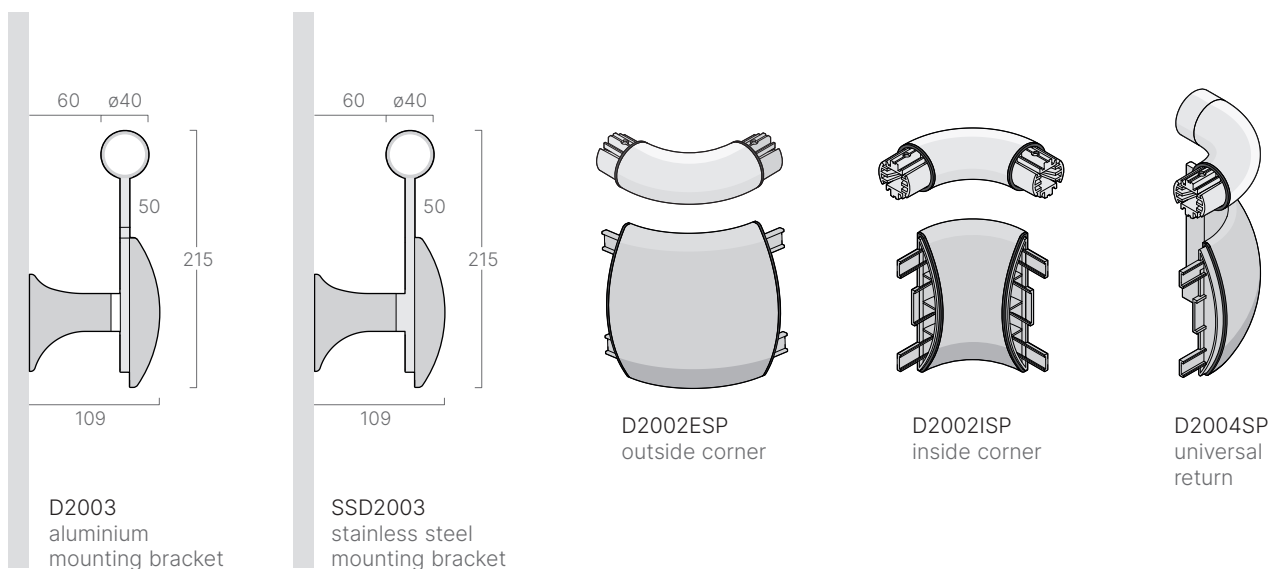

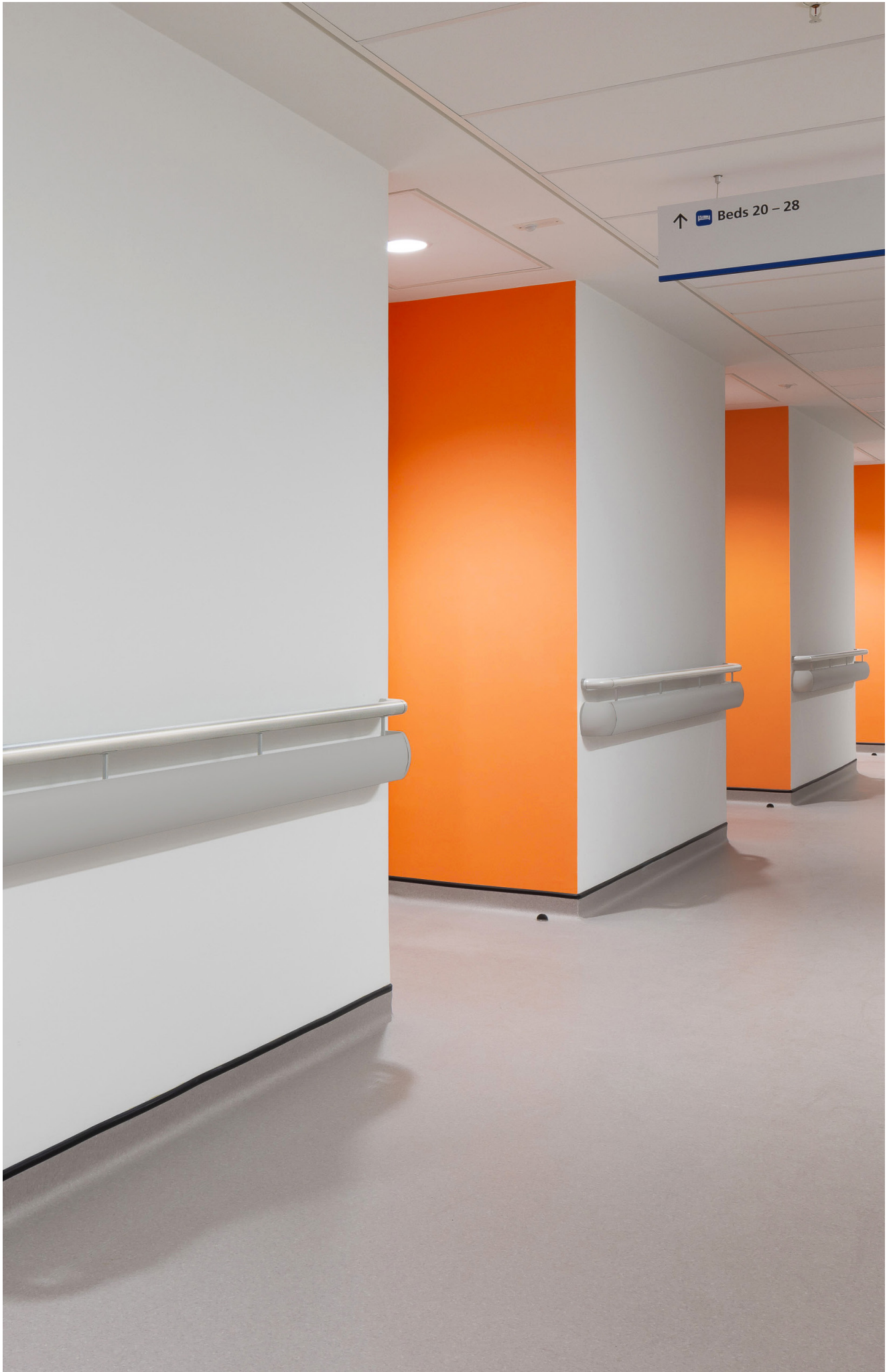

CHR110 Combination Rail

Features

- > Modular system comprising PVC-u covers, aluminium retainers and a full range of finishing accessories
- > Replaceable, through coloured, easy-to-clean covers - textured to conceal the effects of impact and abrasion
- > Closed slots to ensure ends remain in place in event of severe high impact
- > Reveals provide tight, neat joints and are made from a naturally bactericidal polymer that inhibits the growth of bacteria

Information

- > Supplied in 4.0m lengths
- > Accessories include reveal(s)
- > For multiple length installations use splice D200JS
- > Replacement components available to purchase
- > 32 colour options see page 42

Components



CHR110
continuous aluminium retainer with PVC-u cover

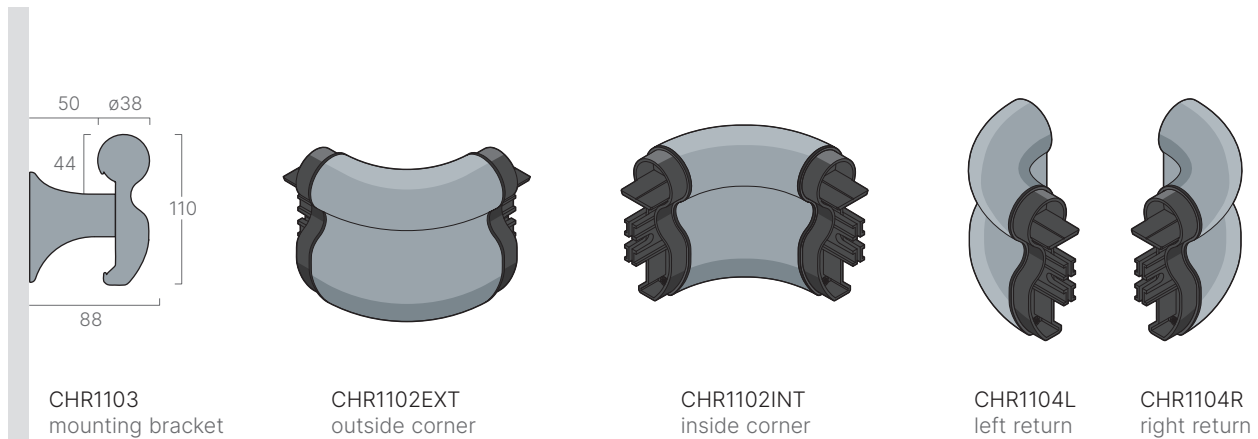

CHR1103
mounting bracket

CHR1102EXT
outside corner

CHR1102INT
inside corner

CHR1104L
left return

CHR1104R
right return



CHR160 Combination Rail

Features

- > Modular system comprising PVC-u covers, aluminium retainers and a full range of finishing accessories
- > Replaceable, through coloured, easy-to-clean covers - textured to conceal the effects of impact and abrasion
- > Closed slots to ensure ends remain in place in event of severe high impact
- > Reveals provide tight, neat joints and are made from a naturally bactericidal polymer that inhibits the growth of bacteria

Information

- > Supplied in 4.0m lengths
- > Accessories include reveal(s)
- > For multiple length installations use splice D200JS
- > Replacement components available to purchase
- > 32 colour options see page 42

Components

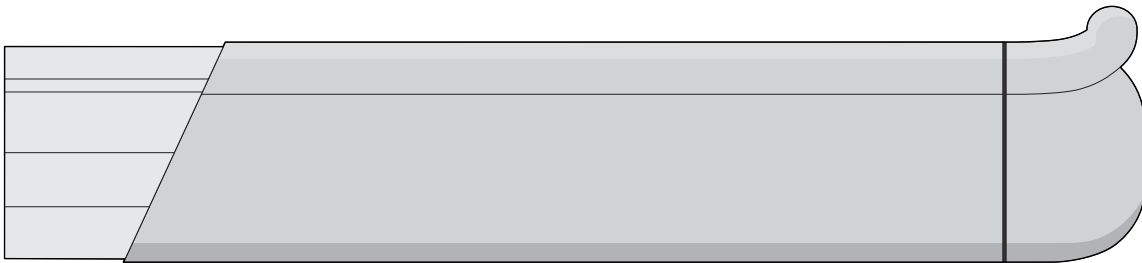

CHR160
continuous aluminium retainer with PVC-u cover

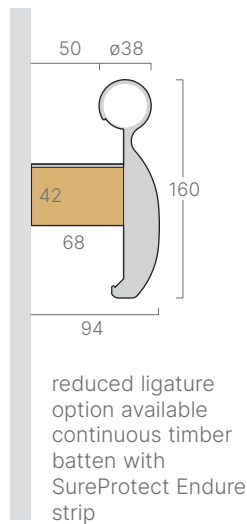
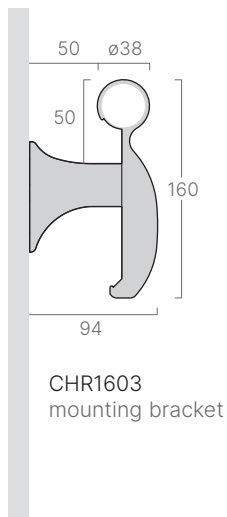

CHR1602
universal corner
inside / outside

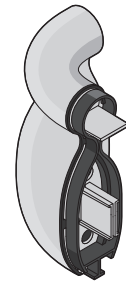

CHR1604L
left return

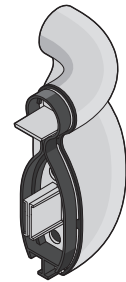

CHR1604R
right return



Visit: www.gradus.com
for full details



Dimensions shown are nominal
Illustrations are in mm



100%
Recyclable



NBS Source
PARTNER



Countess of Chester Hospital